

MasterSeal Roof 2111

Roof waterproofing system based on 1:1 spray applied hybrid polyurea membrane

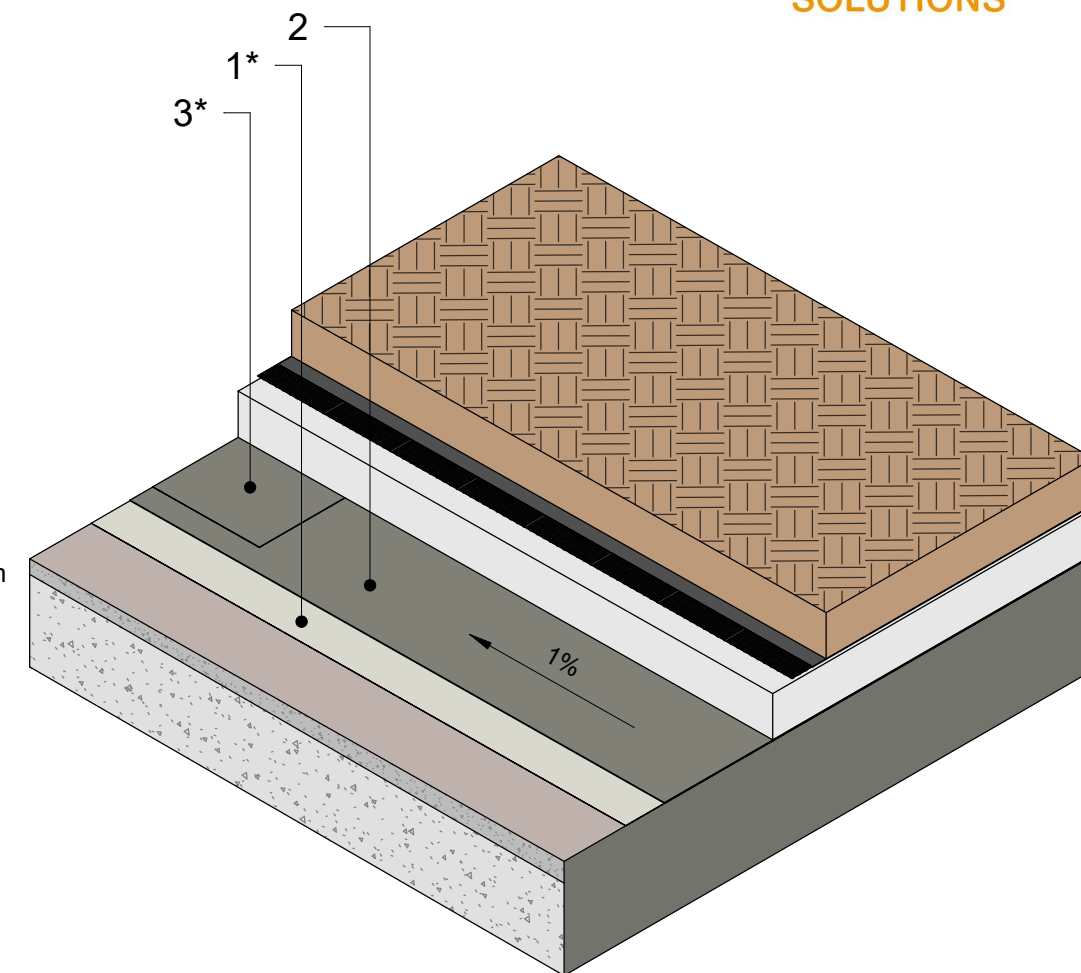
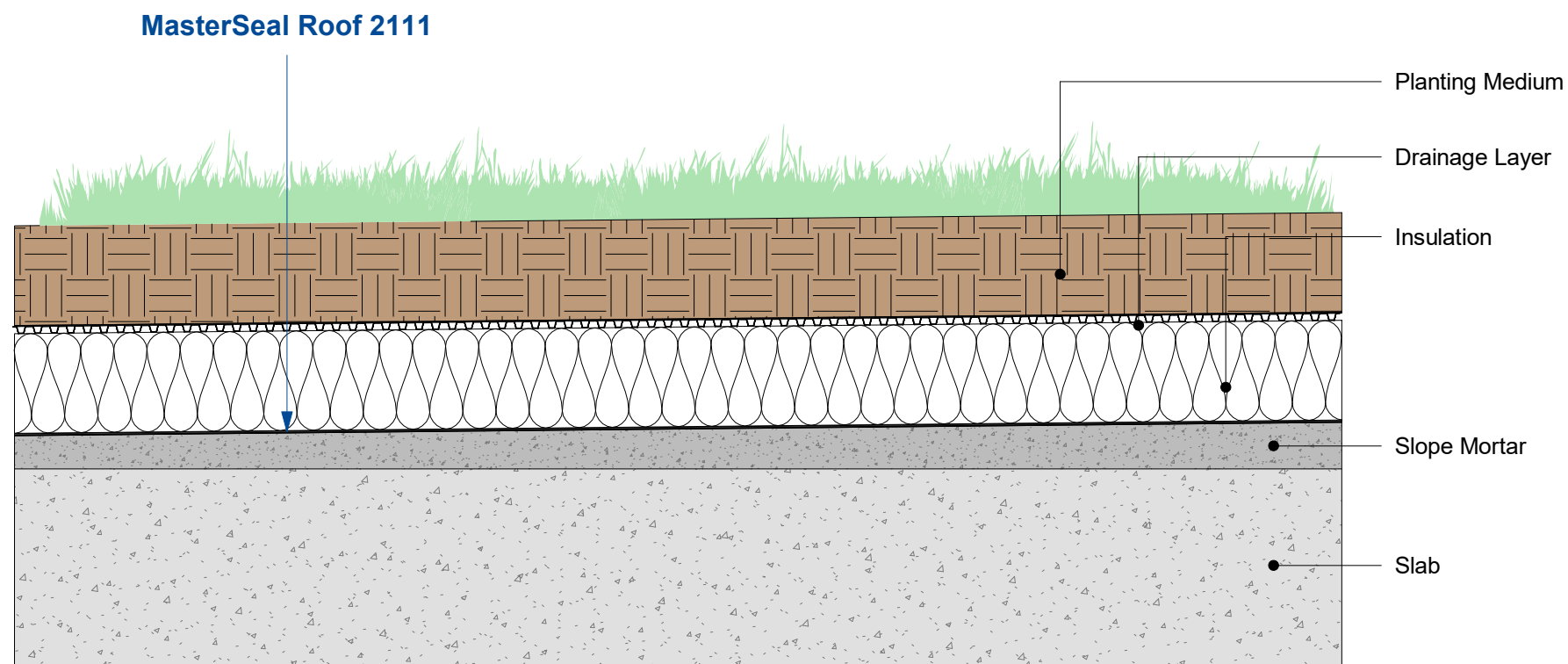

MasterSeal Roof 2111 system composition:

- 1- Primer - MasterSeal P 770
* According to substrates indicated in technical documentation
* Optional broadcast - MasterTop F5
- 2- Membrane - MasterSeal M 811
- 3- Topcoat - MasterSeal TC 269
* For areas where waterproofing surface is unprotected and exposed

DISCLAIMER:
In view of widely varying site conditions and fields of application of our products, this technical document is meant to provide general application guidelines only. This information is based on our present knowledge and experience. The customer is not released from the obligation to conduct careful testing of suitability and possible application for the intended use. The customer is obliged to contact the technical helpline for fields of application not expressly stated in the technical data sheet under "Fields of Application". Use of the product beyond the fields of application as stated in the technical data sheet without previous consultation with Master Builders Solutions and possible resulting damages are in the sole responsibility of the customer. All descriptions, drawings, photographs, data, ratios, weights i.e. stated herein can be changed without advance notice and do not represent the condition of the products as stipulated by contract. It is the sole responsibility of the recipient of our products to observe possible proprietary rights as well as existing laws and provisions.
The reference of trade names of other companies is no recommendation and does not exclude the use of products of similar type. Our information only describes the quality of our products and services and is no warranty. Liability is accepted for incomplete or incorrect particulars in our data sheets only in the event of intent or gross negligence, without prejudice to claims under product liability laws.

A brand of
MECC GROUP

No.	Description	Date

Master Builders Solutions
Liquid-applied waterproofing detailing for inverted Green Roofs

Waterproofing System Composition

Project number WP-DET-GR

Date MAY 2022

01-DET-SYS

Scale 1 : 10

MasterSeal Roof 2111

Roof waterproofing system based on 1:1 spray applied hybrid polyurea membrane

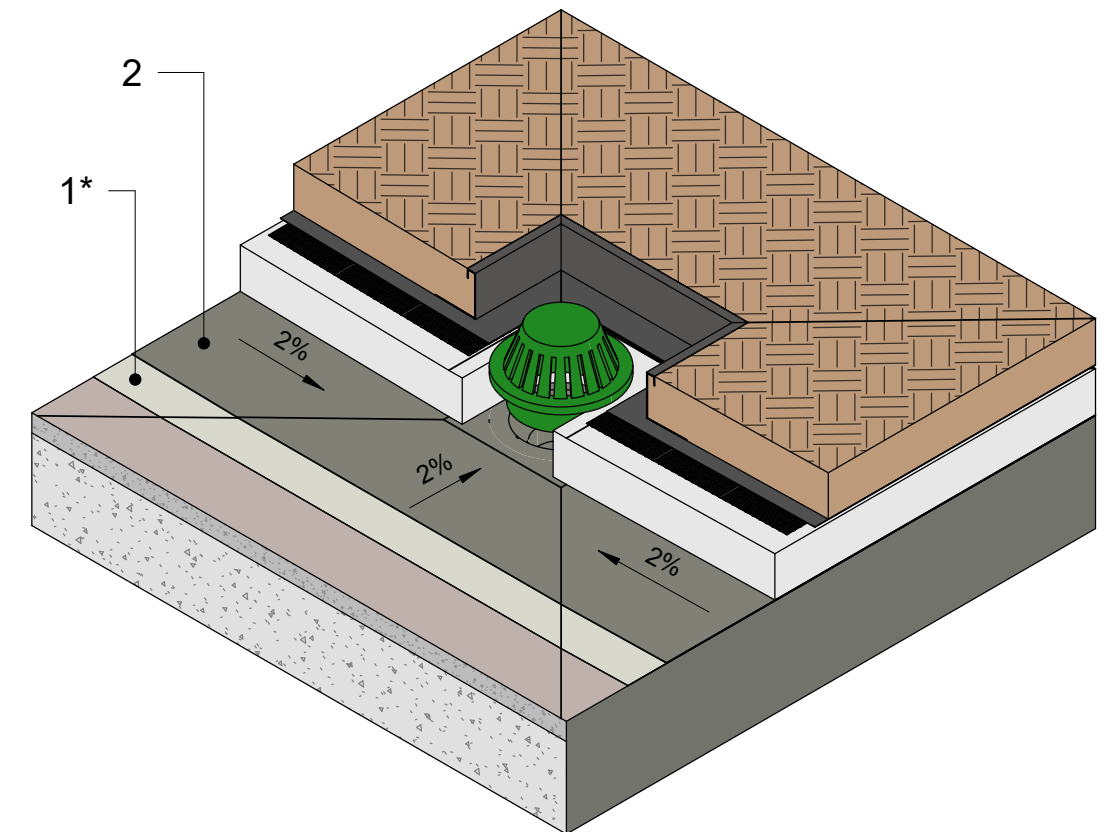
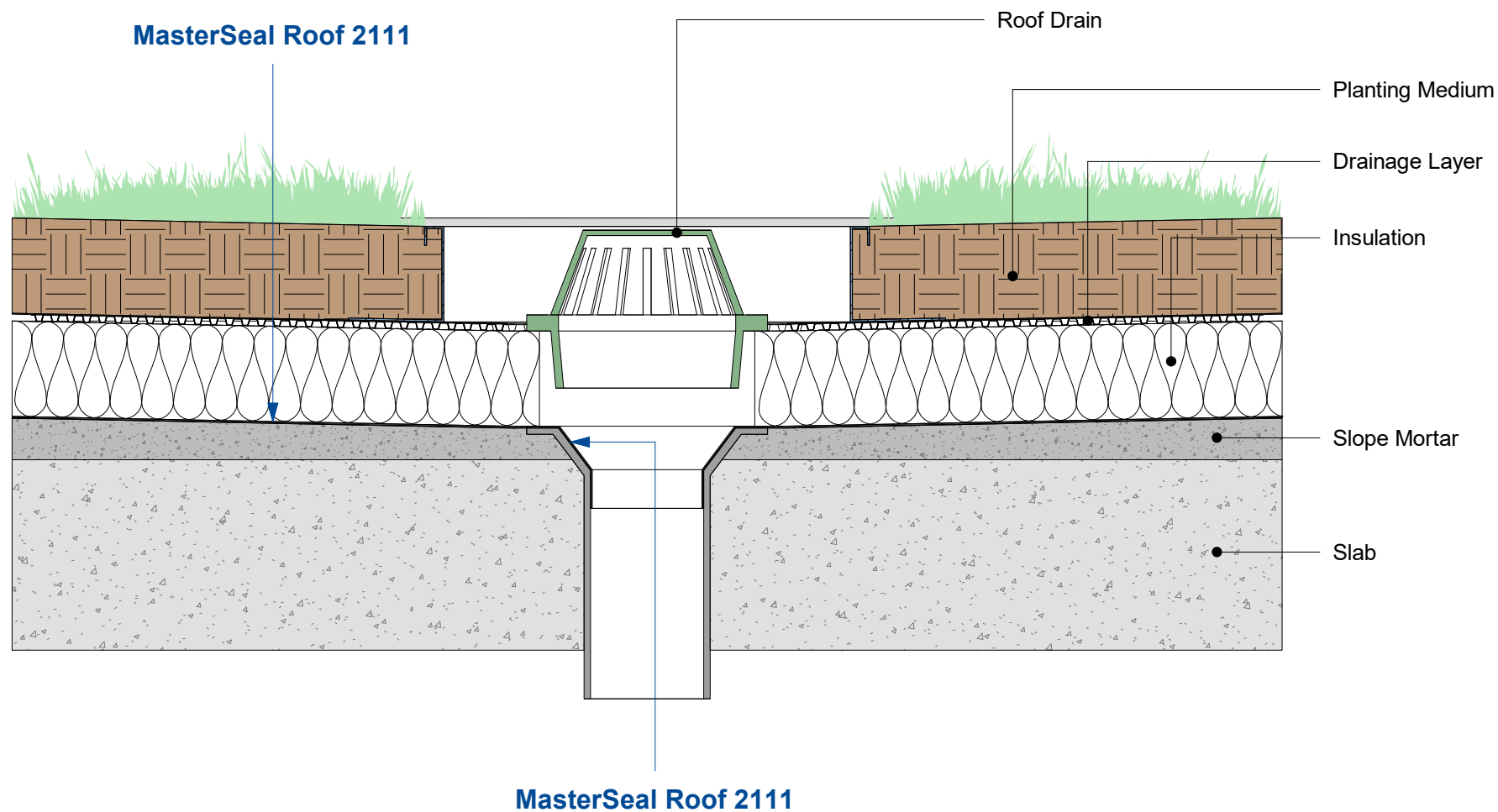

MasterSeal Roof 2111 system composition:

- 1- Primer - MasterSeal P 770
- * According to substrates indicated in technical documentation
- * Optional broadcast - MasterTop F5
- 2- Membrane - MasterSeal M 811
- 3- Topcoat - MasterSeal TC 269
- * For areas where waterproofing surface is unprotected and exposed

DISCLAIMER:
In view of widely varying site conditions and fields of application of our products, this technical document is meant to provide general application guidelines only. This information is based on our present knowledge and experience. The customer is not released from the obligation to conduct careful testing of suitability and possible application for the intended use. The customer is obliged to contact the technical helpline for fields of application not expressly stated in the technical data sheet under "Fields of Application". Use of the product beyond the fields of application as stated in the technical data sheet without previous consultation with Master Builders Solutions and possible resulting damages are in the sole responsibility of the customer. All descriptions, drawings, photographs, data, ratios, weights i.e. stated herein can be changed without advance notice and do not represent the condition of the products as stipulated by contract. It is the sole responsibility of the recipient of our products to observe possible proprietary rights as well as existing laws and provisions.
The reference of trade names of other companies is no recommendation and does not exclude the use of products of similar type. Our information only describes the quality of our products and services and is no warranty. Liability is accepted for incomplete or incorrect particulars in our data sheets only in the event of intent or gross negligence, without prejudice to claims under product liability laws.

A brand of
MECC GROUP

No.	Description	Date

Roof Drain Detail		02-DET-RDR
Project number	WP-DET-GR	
Date	MAY 2022	
Scale	1 : 10	

MasterSeal Roof 2111

Roof waterproofing system based on 1:1 spray applied hybrid polyurea membrane

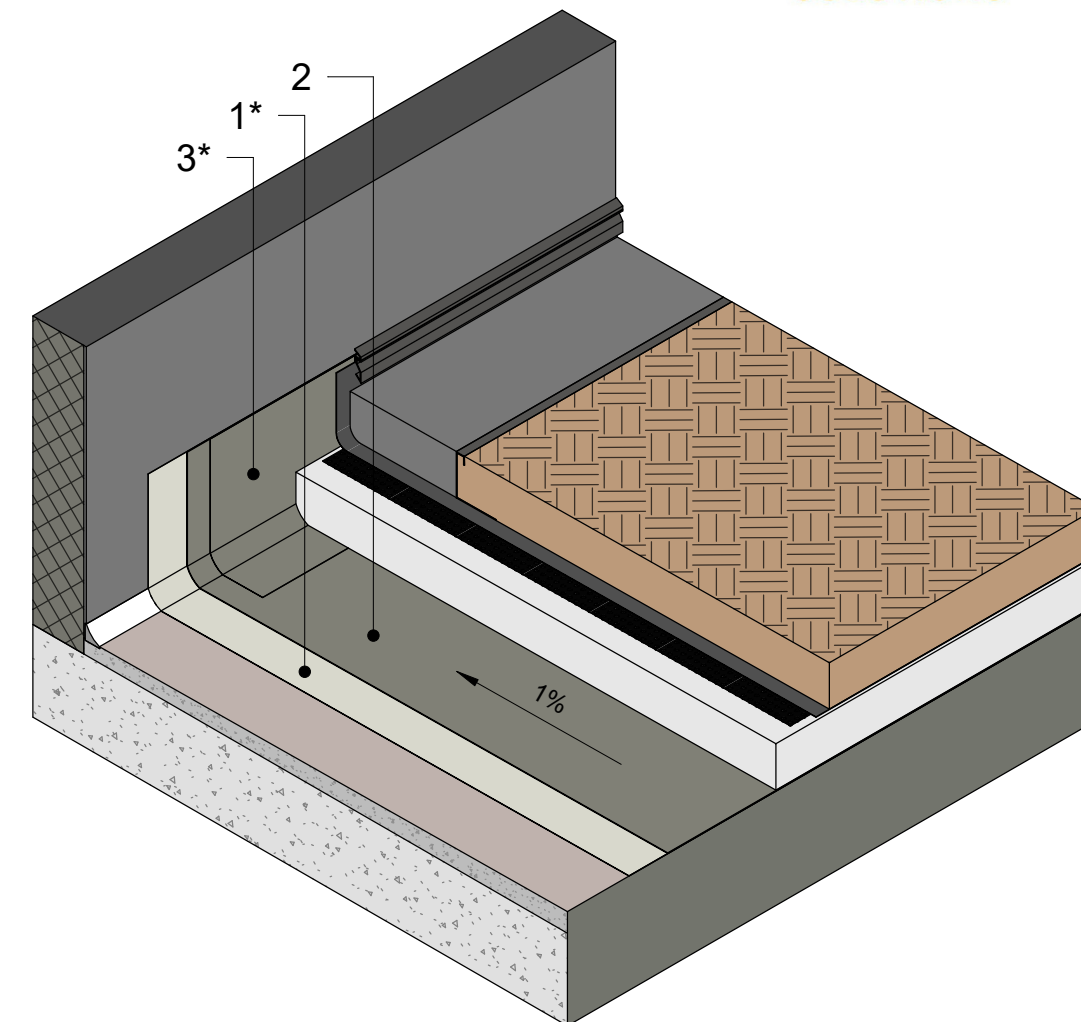
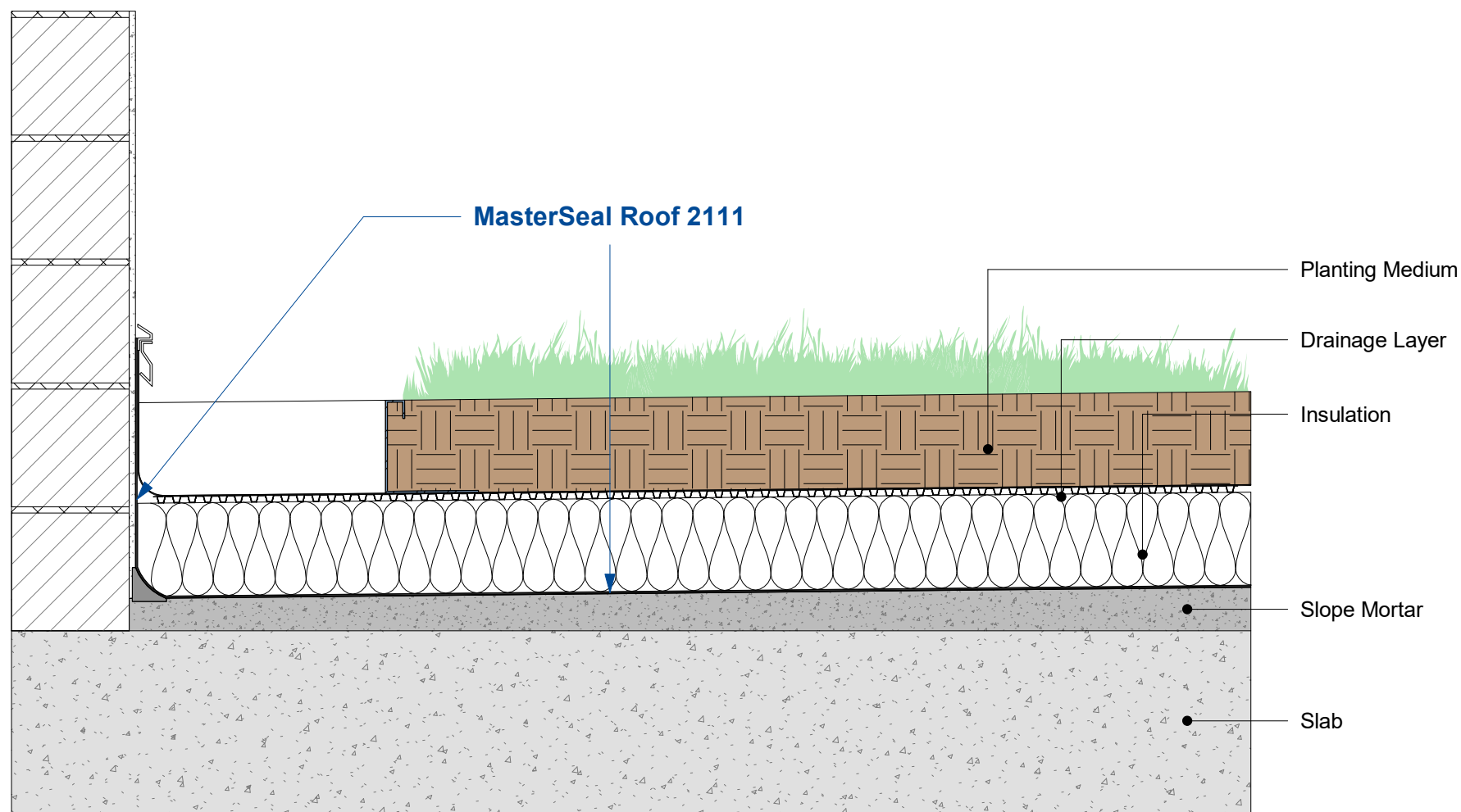

MasterSeal Roof 2111 system composition:

- 1- Primer - MasterSeal P 770
- * According to substrates indicated in technical documentation
- * Optional broadcast - MasterTop F5

- 2- Membrane - MasterSeal M 811

- 3- Topcoat - MasterSeal TC 269
- * For areas where waterproofing surface is unprotected and exposed

DISCLAIMER:
In view of widely varying site conditions and fields of application of our products, this technical document is meant to provide general application guidelines only. This information is based on our present knowledge and experience. The customer is not released from the obligation to conduct careful testing of suitability and possible application for the intended use. The customer is obliged to contact the technical helpline for fields of application not expressly stated in the technical data sheet under "Fields of Application". Use of the product beyond the fields of application as stated in the technical data sheet without previous consultation with Master Builders Solutions and possible resulting damages are in the sole responsibility of the customer. All descriptions, drawings, photographs, data, ratios, weights i.e. stated herein can be changed without advance notice and do not represent the condition of the products as stipulated by contract. It is the sole responsibility of the recipient of our products to observe possible proprietary rights as well as existing laws and provisions.
The reference of trade names of other companies is no recommendation and does not exclude the use of products of similar type. Our information only describes the quality of our products and services and is no warranty. Liability is accepted for incomplete or incorrect particulars in our data sheets only in the event of intent or gross negligence, without prejudice to claims under product liability laws.

A brand of
MECC GROUP

No.	Description	Date

Master Builders Solutions		Wall Encounter with Coving	
Liquid-applied waterproofing detailing for inverted Green Roofs		Project number	WP-DET-GR
		Date	MAY 2022
		03-DET-CVN	
		Scale	1 : 10

MasterSeal Roof 2111

Roof waterproofing system based on 1:1 spray applied hybrid polyurea membrane

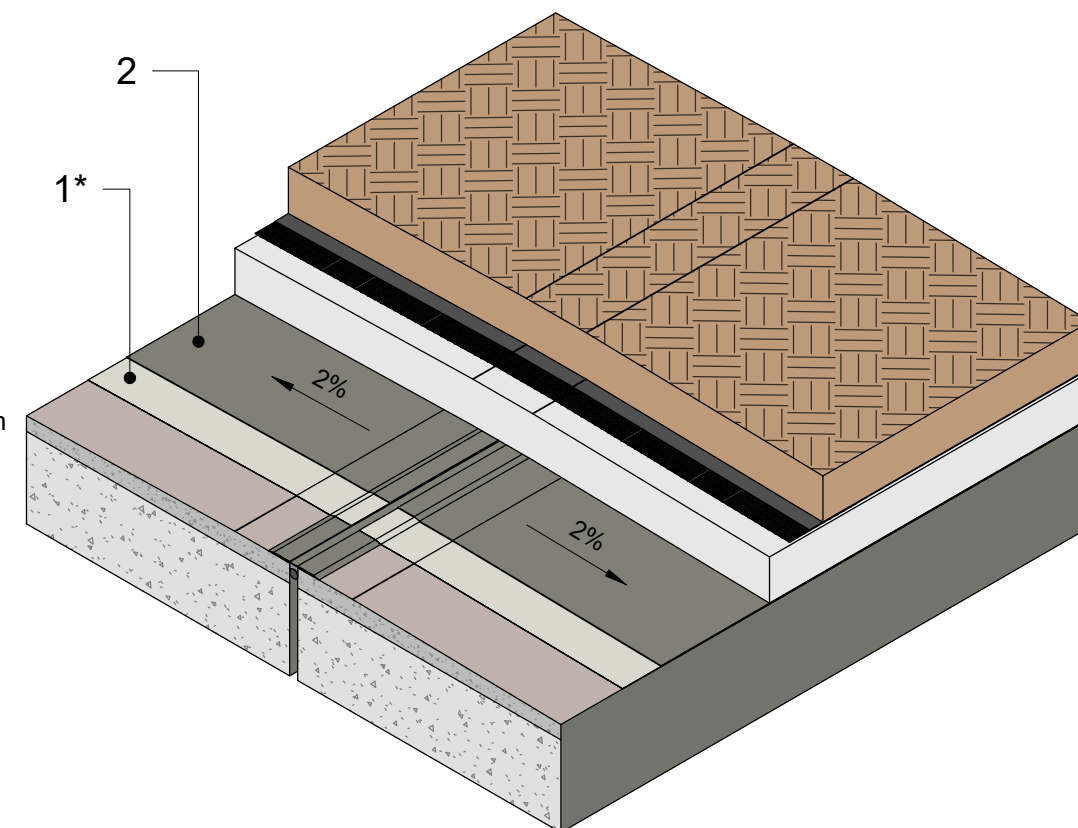
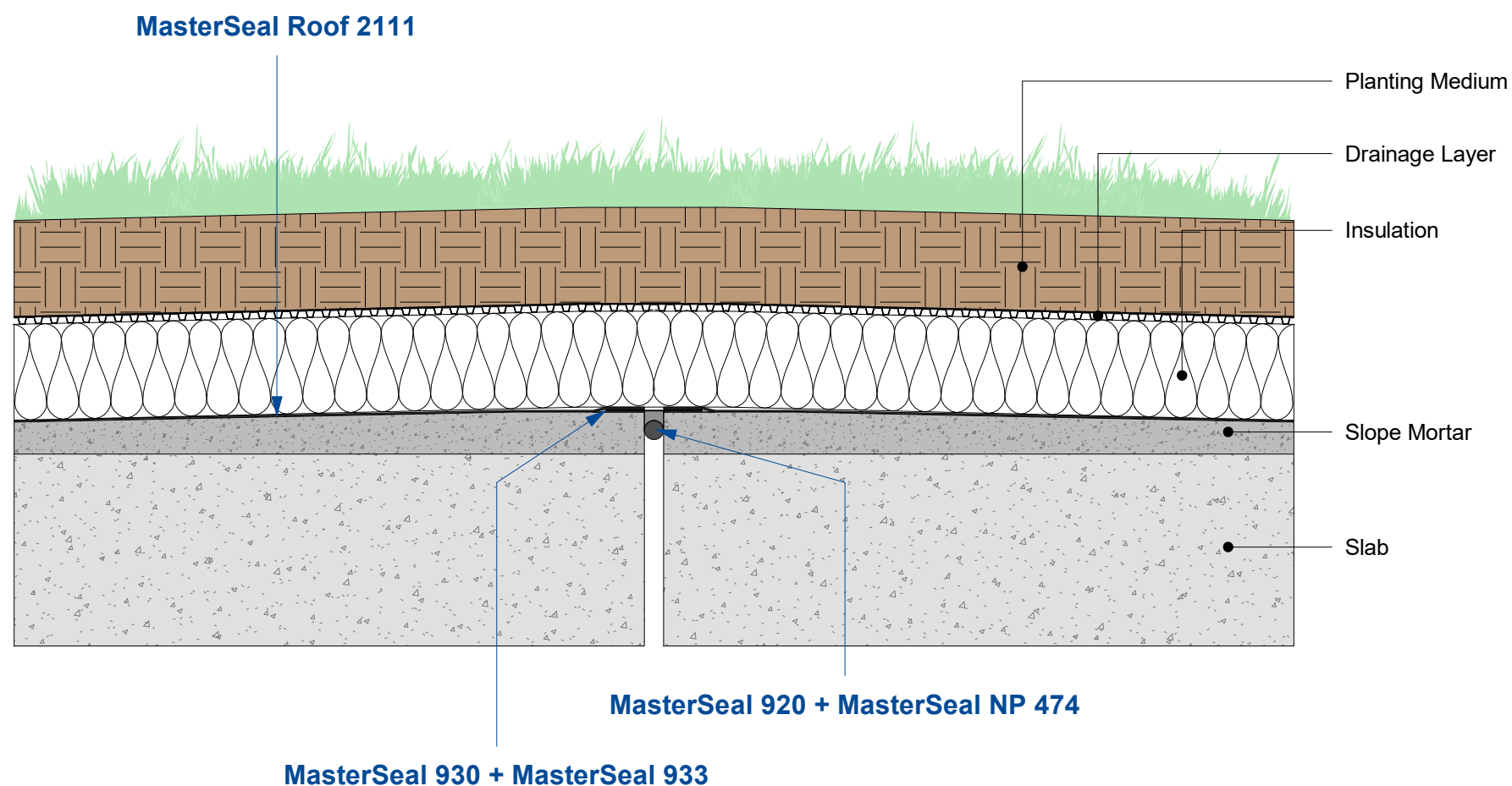

MasterSeal Roof 2111 system composition:

- 1- Primer - MasterSeal P 770
- * According to substrates indicated in technical documentation
- * Optional broadcast - MasterTop F5
- 2- Membrane - MasterSeal M 811
- 3- Topcoat - MasterSeal TC 269
- * For areas where waterproofing surface is unprotected and exposed

DISCLAIMER:
In view of widely varying site conditions and fields of application of our products, this technical document is meant to provide general application guidelines only. This information is based on our present knowledge and experience. The customer is not released from the obligation to conduct careful testing of suitability and possible application for the intended use. The customer is obliged to contact the technical helpline for fields of application not expressly stated in the technical data sheet under "Fields of Application". Use of the product beyond the fields of application as stated in the technical data sheet without previous consultation with Master Builders Solutions and possible resulting damages are in the sole responsibility of the customer. All descriptions, drawings, photographs, data, ratios, weights i.e. stated herein can be changed without advance notice and do not represent the condition of the products as stipulated by contract. It is the sole responsibility of the recipient of our products to observe possible proprietary rights as well as existing laws and provisions.
The reference of trade names of other companies is no recommendation and does not exclude the use of products of similar type. Our information only describes the quality of our products and services and is no warranty. Liability is accepted for incomplete or incorrect particulars in our data sheets only in the event of intent or gross negligence, without prejudice to claims under product liability laws.

A brand of
MECC GROUP

No.	Description	Date

Expansion Joint Detail		04-DET-EPJ
Project number	WP-DET-GR	
Date	MAY 2022	
Scale		1 : 10